

# 6FM150D-X 12V 150Ah(10hr)

The rechargeable batteries are lead-lead dioxide systems. The dilute sulfuric acid electrolyte is absorbed by separators and plates and thus immobilized. Should the battery be accidentally overcharged producing hydrogen and oxygen, special one-way valves allow the gases to escape thus avoiding excessive pressure build-up. Otherwise, the battery is completely sealed and is, therefore, maintenance-free, leak proof and usable in any position.

## Battery Construction

Component	Positive plate	Negative plate	Container	Cover	Safety valve	Terminal	Separator	Electrolyte
Raw material	Lead dioxide	Lead	ABS	ABS	Rubber	Copper	Fiberglass	Sulfuric acid

## General Features

- Absorbent Glass Mat (AGM) technology for efficient gas recombination of up to 99% and freedom from electrolyte maintenance or water adding.
- Not restricted for air transport-complies with IATA/ICAO Special Provision A67.
- UL-recognized component.
- Can be mounted in any orientation.
- Computer designed lead, calcium tin alloy grid for high power density.
- Long service life, float or cyclic applications.
- Maintenance-free operation.
- Low self discharge.

## Dimensions and Weight

Length(mm / inch)..... 485 / 19.09  
 Width(mm / inch)..... 172 / 6.77  
 Height(mm / inch)..... 240 / 9.45  
 Total Height(mm / inch)..... 240 / 9.45  
 Approx. Weight(Kg / lbs)..... 47 / 103.6

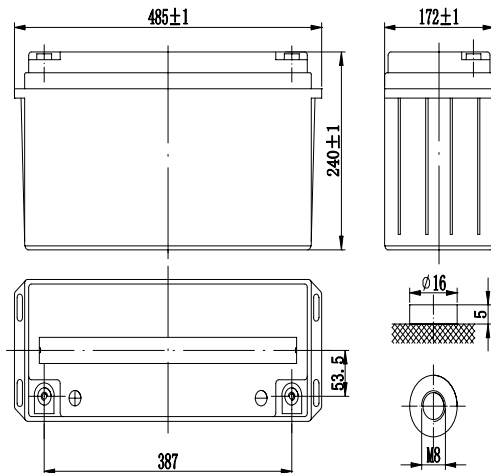

## Performance Characteristics

Nominal Voltage .....12V  
 Number of cell .....6  
 Design Life .....10 years  
 Nominal Capacity 77°F(25°C)  
 20 hour rate (7.5A, 10.5V)..... 150Ah  
 10 hour rate (14.3A, 10.5V)..... 143Ah  
 5 hour rate (24.9A, 10.5V)..... 124.5Ah  
 1 hour rate (96A, 9.6V)..... 96Ah  
 Internal Resistance  
 Fully Charged battery 77°F(25°C)..... 3.7mOhms  
 Self-Discharge  
 3% of capacity declined per month at 20°C(average)  
 Operating Temperature Range  
 Discharge .....-20~60°C  
 Charge .....-10~60°C  
 Storage .....-20~60°C  
 Max. Discharge Current 77°F(25°C) .....1000A(5s)  
 Short Circuit Current ..... 2700A  
 Charge Methods: Constant Voltage Charge 77°F(25°C)  
 Cycle use ..... 14.4-14.7V  
 Maximum charging current ..... 45A  
 Temperature compensation .....-30mV/°C  
 Standby use ..... 13.6-13.8V  
 Temperature compensation .....-20mV/°C

## Discharge Constant Current (Amperes at 77°F25°C)

End Point Volts/cell	5min	10min	15min	30min	1h	3h	5h	10h	20h	100h
1.60V	440	343	279	160	101	40.7	27.7	15.9	8.15	1.81
1.65V	409	322	263	156	98.7	39.8	27.3	15.7	8.08	1.80
1.70V	379	302	251	152	96.7	38.9	26.7	15.4	7.98	1.78
1.75V	348	282	236	146	93.8	38.2	26.1	15.2	7.87	1.76
1.80V	313	259	222	143	90.7	37.0	25.7	15.0	7.74	1.74

## Discharge Constant Power (Watts at 77°F25°C)

End Point Volts/cell	5min	10min	15min	30min	45min	1h	2h	3h	5h	100h
1.60V	751	598	492	320	218	198	111	77.8	53.4	3.60
1.65V	721	569	474	309	214	195	109	76.9	53.1	3.59
1.70V	673	538	457	300	209	192	107	75.9	52.7	3.58
1.75V	627	510	437	291	203	187	105	75.0	52.3	3.57
1.80V	577	478	417	281	199	181	104	73.8	51.8	3.56

(Note)The above characteristics data are average values obtained within three charge/discharge cycles not the minimum values.

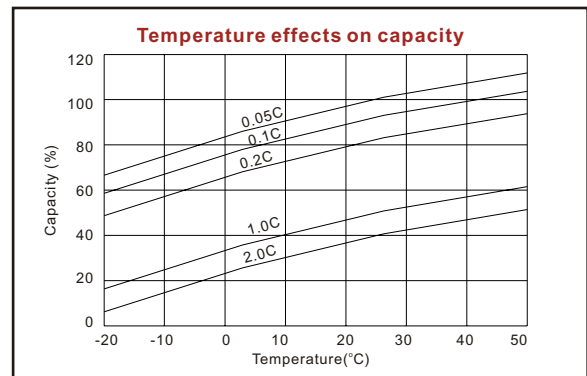
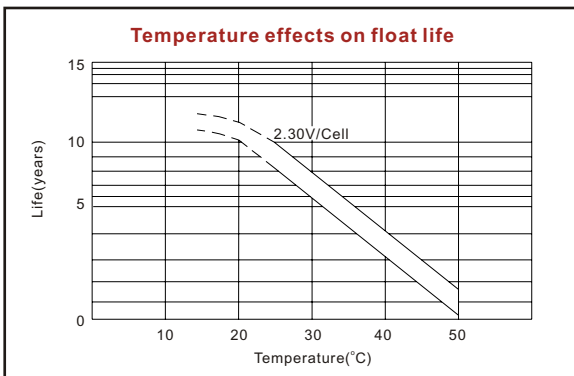
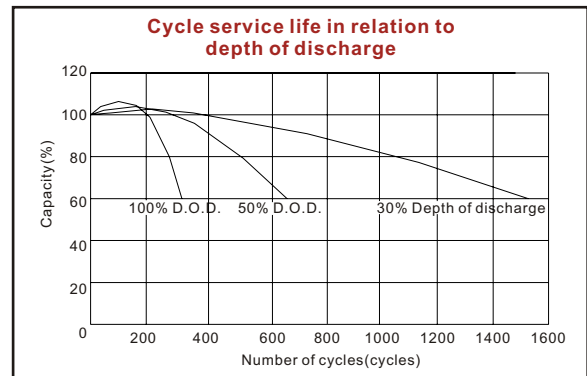
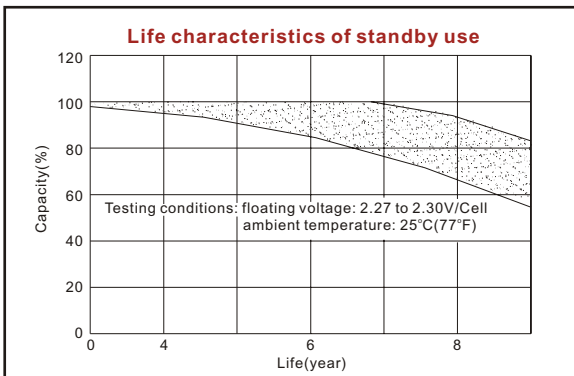
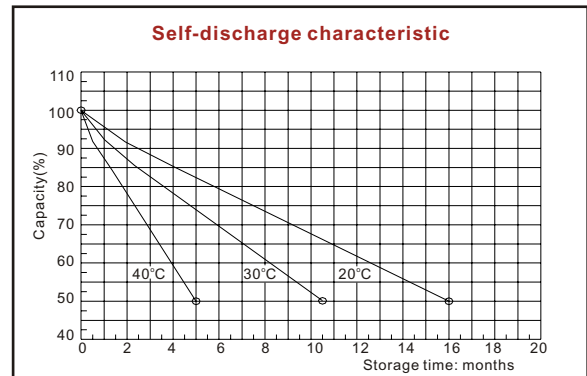
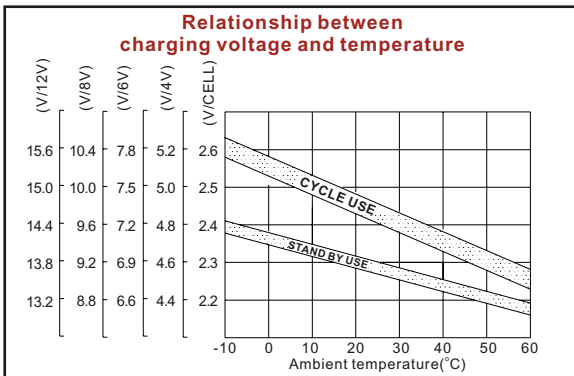
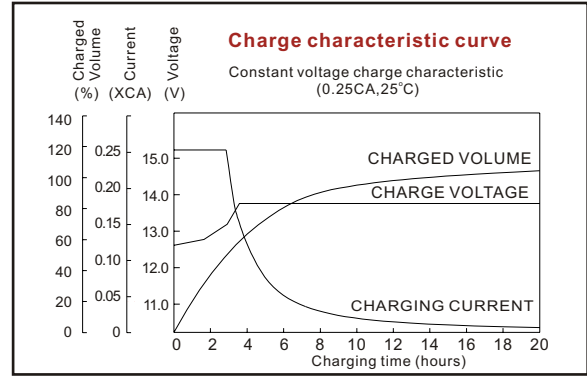
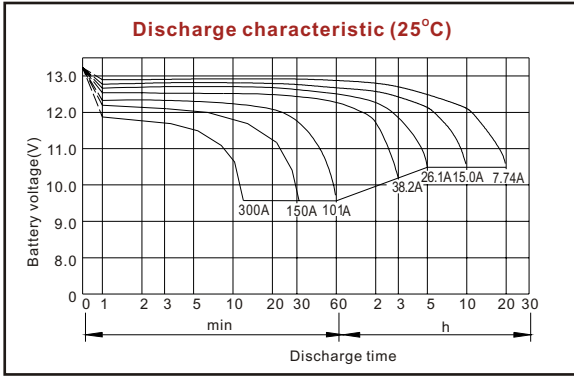

ISO9001:2000

MH25860

G4M19906-9202-E-16

**Shenzhen Center Power Tech. Co., Ltd.**  
 Center Power Industrial Park, Tongfu Industrial District Dapeng Town, 518120 Shenzhen, China  
 Tel: (+86-755) 8431 8088 Fax: (+86-755) 8431 8038 E-mail: sales@vision-batt.com

[www.vision-batt.com](http://www.vision-batt.com)